

Models BL-301/BL-301-GR Blast Protection Damper Operation, Storage & Maintenance Instructions

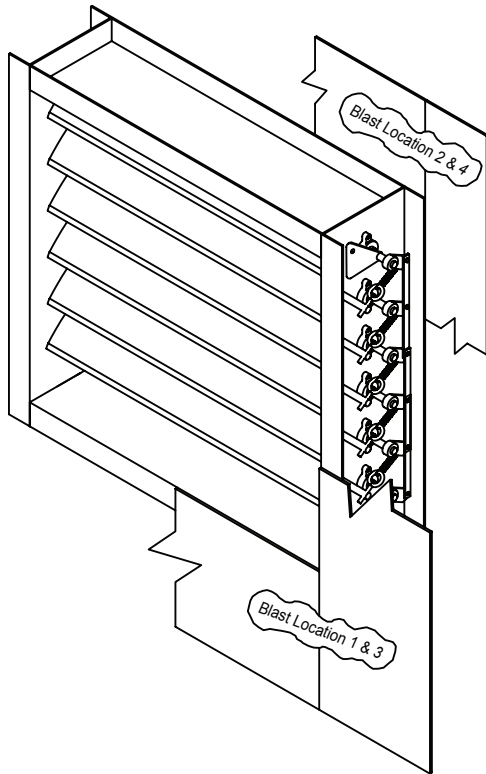

Safety Warning

Improper service or maintenance can cause property damage, injury or death. Read the operating and maintenance instructions thoroughly before servicing this equipment.

Storage Of Dampers Prior To Installation

The basic intent of proper storage of blast dampers is to prevent physical damage, material corrosion, and deterioration of organic material.

- Visually inspect the damper for damage. Store indoors, protected from sunlight, moisture and flooding. Protect dampers from debris and dirt accumulation.
- The damper should be stored in a clean dry area. Damage due to moisture is not covered by Damper warranty.
- Isolate Damper from any high vibration loading.

Safety Caution!

Use Caution when moving blast dampers as they are extremely heavy and can cause injury or death if handled improperly. Lifting hook anchor holes are located on both sides of the damper frame, near the top. Use both anchor points when lifting and locating the damper.

Damper Maintenance

MAT's dampers are designed to be trouble free and hassle free under normal operation. Dampers are to be installed square and straight so as to prevent binding during operation.

The following annual damper maintenance suggestions will help insure proper damper operation and increase the life expectancy of the damper.

- Over the course of time, dirt and grime may collect on damper surface. The damper surface should be cleaned to insure optimal airflow.
- Make sure that parts such as linkage, bearings, etc. that are intended to move freely can do so. Lubricating these components can prevent possible rusting and unnecessary friction.
- The flanged ball bearings do not require lubrication.
- Remove foreign materials that may be interfering with blade closure or effective sealing of blades with each other or with the frame.
- Annually Inspect Linkage and Springs to make sure there is no binding.
- Annually cycle damper (open and close), making sure that springs and blade locks are functioning properly.

Models BL-301/BL-301-GR Blast Protection Damper Operation, Storage & Maintenance Instructions

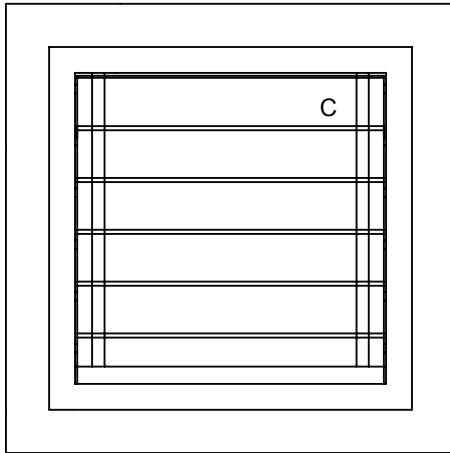

Blade Lock Reset (2 per damper, 1 per jamb)

Spring loaded pin with pull handle (in the airstream), locks blades in the closed position when the linkage passes by the pin in the jamb.

Handle can be pulled to reset damper (blades return to the open position).

Pull and twist handle to disengage the blade lock feature.

